

Catálogo

Celosías > **Gradpanel** > Acero >



Serie R



Gradpanel Serie R 314



Catálogo

Celosías > Gradpanel > Acero >

Serie R

Índice

1. Galería de imágenes	Página 03-04
2. Tipos de lamas (Rombo 165)	Página 05
3. Tipos de lamas (Rombo 206)	Página 06
4. Tipos de lamas (Rombo 320)	Página 06
5. Tipos de lamas (Rombo 470)	Página 06
6. Descripción	Página 07
7. Productos	Página 07
8. Uso de aplicaciones	Página 07
9. Tipos de Rombo	Página 08
10. Tipos de perfiles	Página 09
11. Tabla de aplicaciones. Tipo de Perfilería. Dimensiones máximas Panel (Rombo 165)	Página 11
12. Tabla de aplicaciones. Tipo de Perfilería. Dimensiones máximas Panel (Rombo 206)	Página 12
13. Tabla de aplicaciones. Tipo de Perfilería. Dimensiones máximas Panel (Rombo 320)	Página 13
14. Tabla de aplicaciones. Tipo de Perfilería. Dimensiones máximas Panel (Rombo 470)	Página 14
15. Tabla de accionamientos	Página 15
16. Carta de acabados	Página 16
17. Protección solar y ahorro energético	Página 17-18



Catálogo

Celosías > Gradpanel > Acero >

Serie R

1. Galeria de imagenes

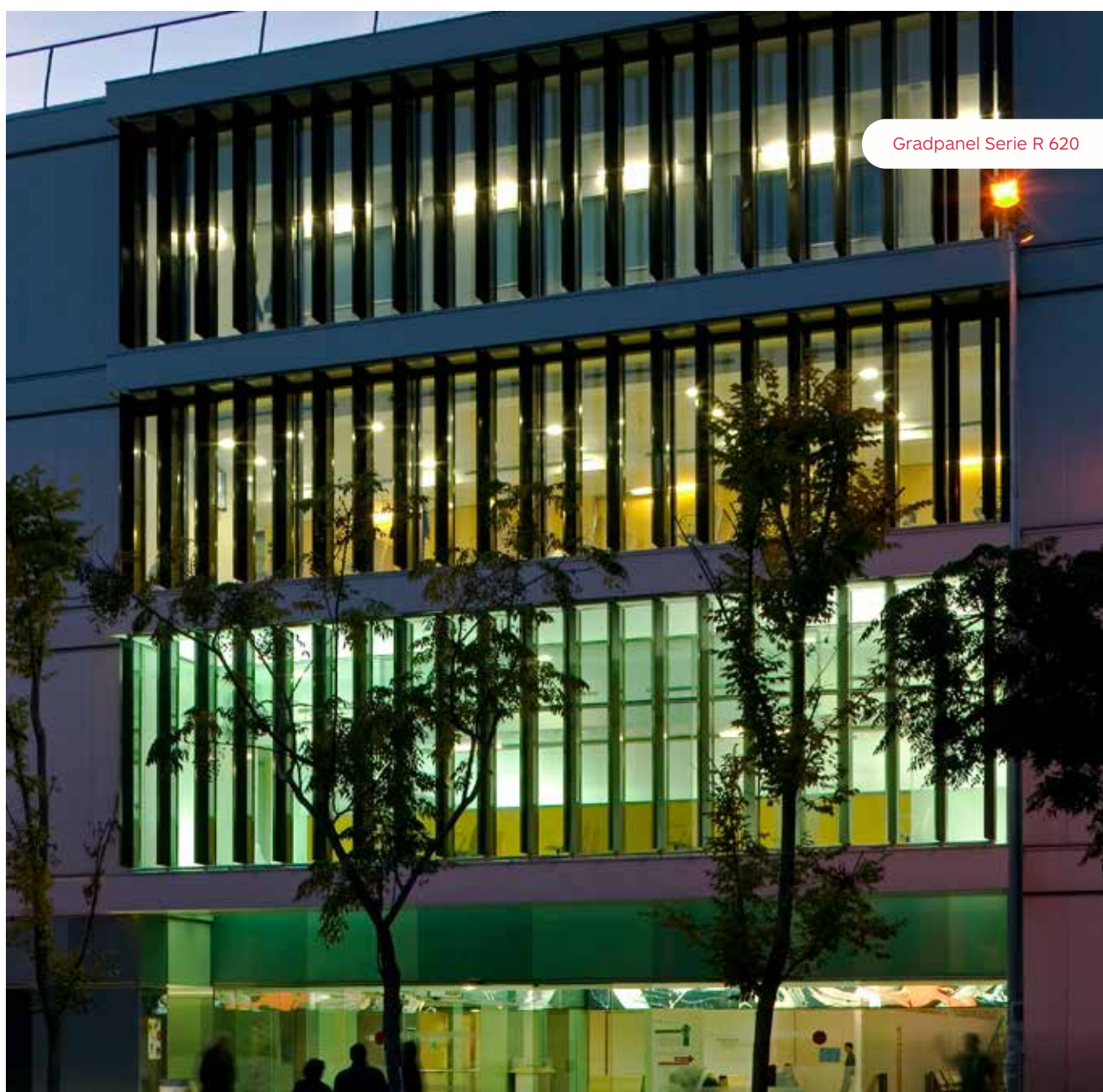

Catálogo

Celosías > Gradpanel > Acero >
Serie R

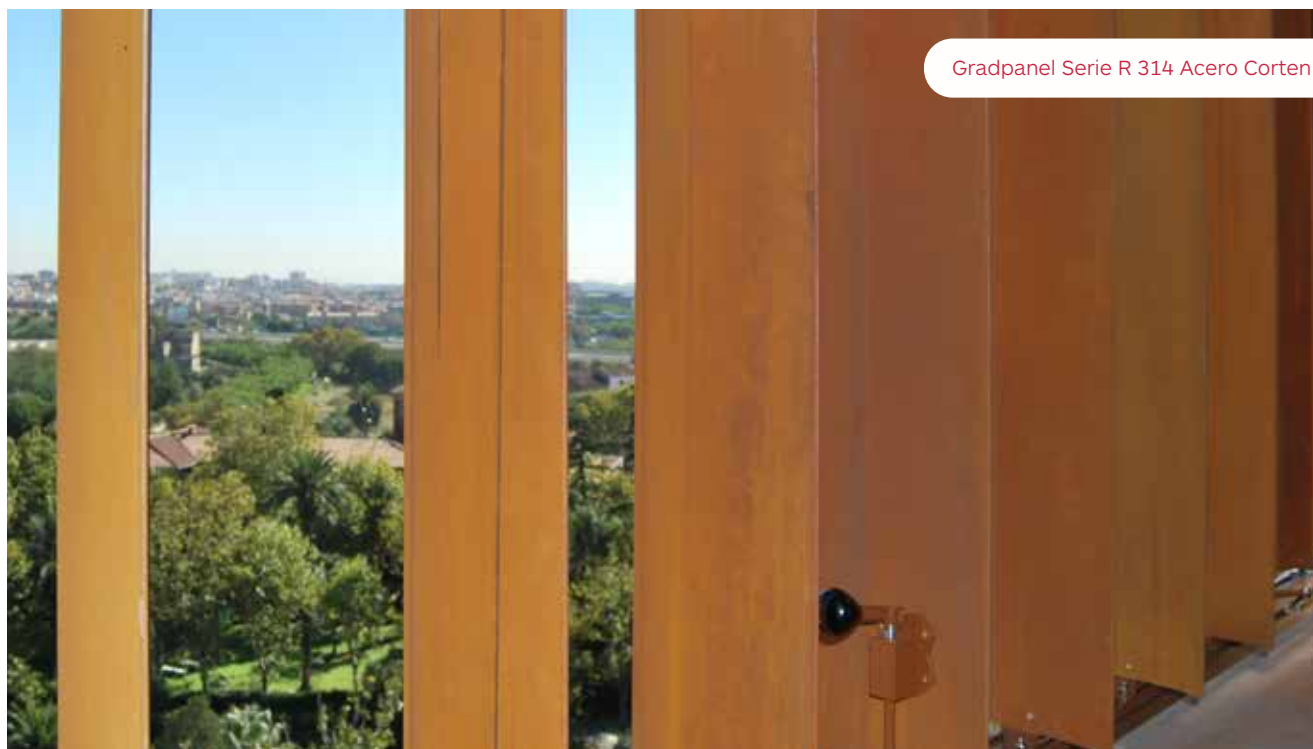

Gradpanel Serie R 314 Acero Corten

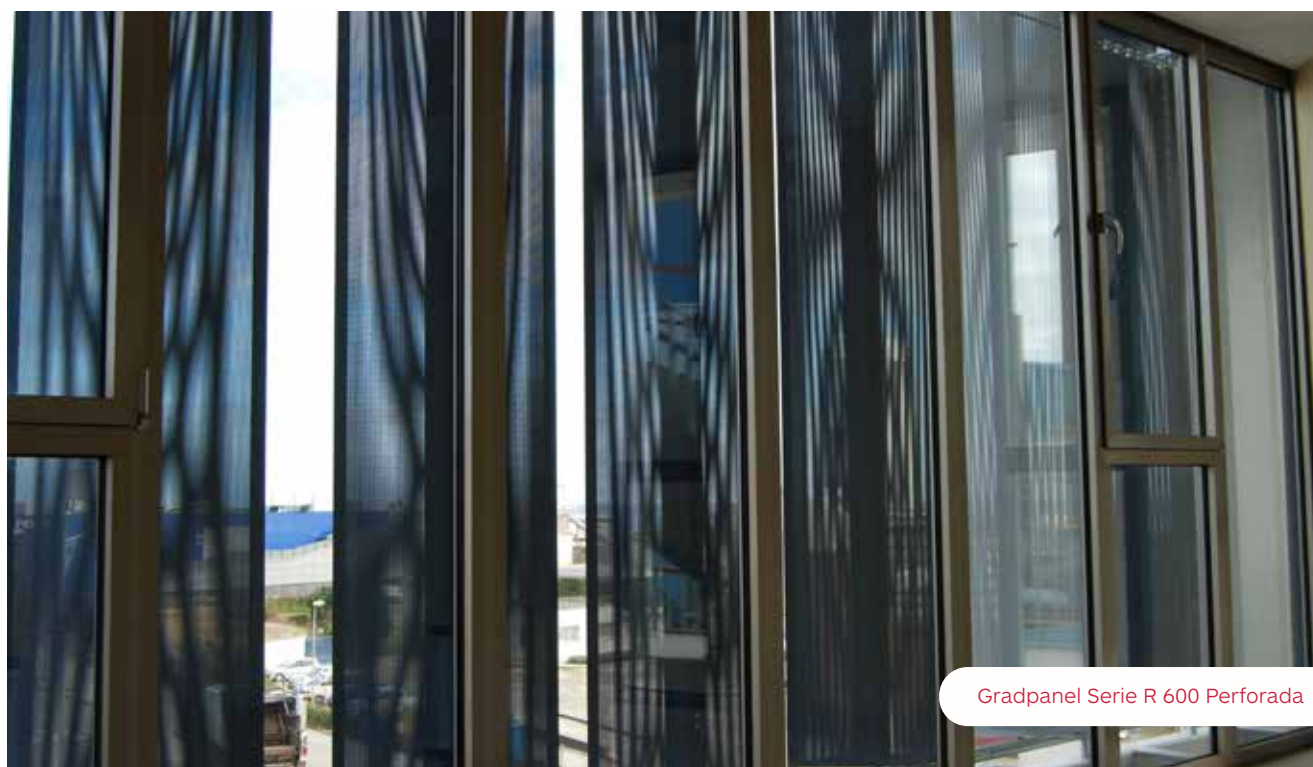

Gradpanel Serie R 600 Perforada



Catálogo

Celosías > Gradpanel > Acero >
Serie R



Infografía: R 250

2. Tipos de Lamas (Rombo 165)



R 200



R 220



R 235



R 250



Catálogo

Celosías > Gradpanel > Acero >

Serie R

3. Tipos de Lamas (Rombo 206)



R 250



R 314



R 335



R 400

4. Tipos de Lamas (Rombo 320)



R 400



R 480



R 500



R 600

5. Tipos de Lamas (Rombo 470)

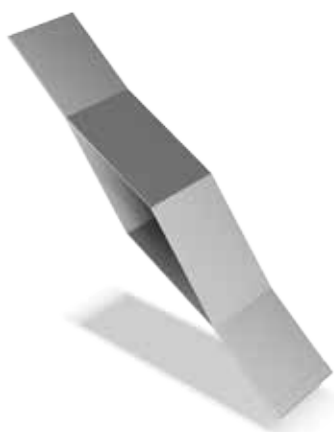

R 600



R 620



Catálogo





Celosías > Gradpanel > Acero >

Serie R



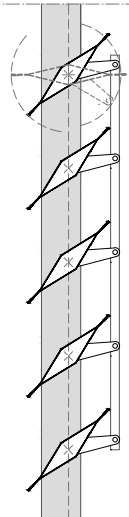
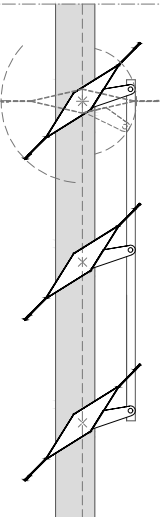
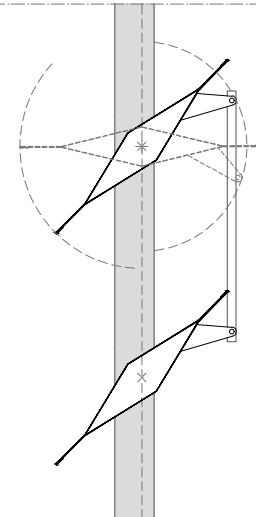
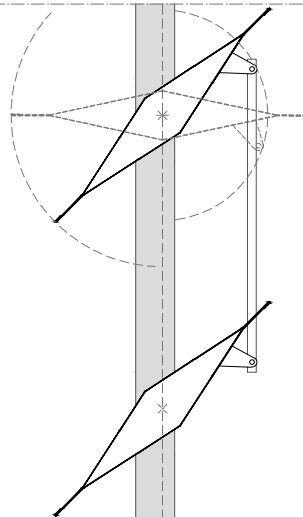



6. Descripción

Celosías de acero galvanizada de lamas fijas y orientables en forma de rombo, tubulares perfiladas, colocadas en horizontal o verticalmente para aplicación marco fijo entre montantes o marcos vistos de aluminio extruido para lamas orientables y fijas. Posibilidad de lamas perforadas.

7. Productos

R 200 / 220 / 235 / 250	R 314 / 335 / 400	R 480 / 500 / 600	R 620
			
			
200 x 40 mm 220 x 40 mm 235 x 40 mm 250 x 40 mm	314 x 50 mm 335 x 50 mm 400 x 50 mm	480 x 80 mm 500 x 80 mm 600 x 80 mm	620x100 mm

8. Uso de Aplicaciones

								
Paramento	Marco fijo	Corredero	Practicable batiente	Practicable Pivotante	Proyectable	Corrugable batiente	Corrugable Pivotante	Levadizo



Catálogo

Celosías > Gradpanel > Acero >

Serie R

9. Tipos de Rombo

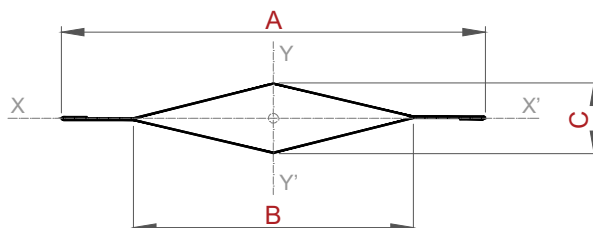

* Norma UNE "Resistencia al viento"

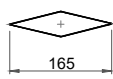
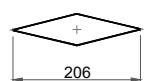
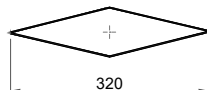
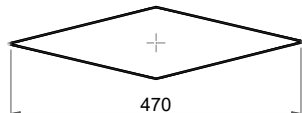
SERIE R			LONGITUDES MÁXIMAS (mm)			
Cota B [mm]	Cota A [mm]	Cota C [mm]	PANEL HORIZONTAL		PANEL VERTICAL	
			GH	Clase 6*	GH	Clase 6*
ROMBO 	200	40	3200	3000	3378	3250
	220	40	3100	2950	3278	3150
	235	40	3000	2850	3178	3050
	250	40	3000	2850	3178	3050
ROMBO 	250	40	3800	3800	4378	4200
	314	50	3700	3550	4078	3900
	335	50	3900	3750	4178	4000
	400	50	3800	3650	4178	4000
ROMBO 	400	50	5700	5500	6378	6150
	480	80	5400	5200	5978	5850
	500	80	5400	5200	5978	5850
	600	80	5100	4950	5678	5550
ROMBO 	600	100	6550	6400	6528	7150
	620	100	6550	6400	6528	7150

Medidas superiores a 6 m consultar



Catálogo

Celosías > Gradpanel > Acero >

Serie R

10. Tipos de perfiles

*Según tabla aplicaciones página 11-14

Marcos

Marco Puerta
40 x 50 mm

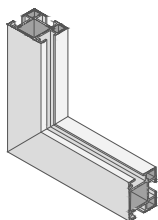

Marco Bala
80 x 50 mm

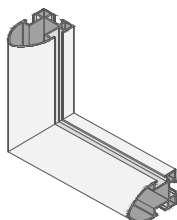

Montantes

Perfil Puerta
40 x 50 mm

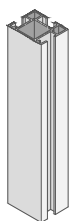

Perfil Bala
80 x 50 mm



Catálogo

Celosías > Gradpanel > Acero >

Serie R

Especificaciones Técnicas

















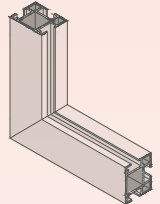
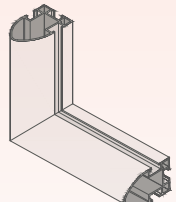

Catálogo

Celosías > Gradpanel > Acero >

Serie R

11. Aplicaciones. Tipo de Perfilera. Dimensiones máximas Panel (ancho x alto)* (Rombo 165)

Aplicación	Panel	Tipo Perfilera	R 200	R 220	R 235	R 250	TIPO PERFILERIA
							
 MARCO FIJO	Sin División	Perfil Puerta Perfil Bala Marco Puerta Marco Bala	3000 x ∞	2950 x ∞	2850 x ∞	2850 x ∞	 Perfil Puerta (40x50) mm  Perfil Bala (80x50) mm  Marco Puerta (40x50) mm  Marco Bala (80x50) mm
 CORBE DE NO	Sin División	—	—	—	—	—	
 CORBE DE NO	Con División	—	—	—	—	—	
 PRACTICABLE BATENIENTE	Sin División	—	—	—	—	—	
 PRACTICABLE POSITIVO	Sin División	—	—	—	—	—	
 PRACTICABLE	Sin División	—	—	—	—	—	
 PRACTICABLE CON DIVISION	Con División	—	—	—	—	—	
 CORRUGABLE BATENIENTE	Sin División	—	—	—	—	—	
 CORRUGABLE POSITIVO	Sin División	—	—	—	—	—	
 LEVANTE	Sin División	—	—	—	—	—	
 LEVANTE CON DIVISION	Con División	—	—	—	—	—	

(Cotas en mm)



















Catálogo

Celosías > Gradpanel > Acero >

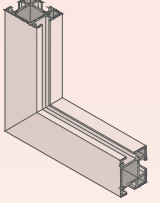
Serie R

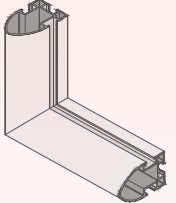
12. Aplicaciones. Tipo de Perfilera. Dimensiones máximas Panel (ancho x alto)* **(Rombo 206)**

Aplicación	Panel	Tipo Perfilera	R 250	R 314	R 335	R 400	TIPO PERFILERIA
							
 MARCO FIJO	Sin División	Perfil Puerta Perfil Bala Marco Puerta Marco Bala	3800 x ∞	3550 x ∞	3750 x ∞	3650 x ∞	 Perfil Puerta (40x50) mm
 CORBEO	Sin División	—	—	—	—	—	
 CORBEO	Con División	—	—	—	—	—	
 PRACTICABLE BATIENTE	Sin División	—	—	—	—	—	 Perfil Bala (80x50) mm
 PRACTICABLE POSITIVO	Sin División	—	—	—	—	—	
 PRACTICABLE	Sin División	—	—	—	—	—	
 PRACTICABLE CON DIVISION	Con División	—	—	—	—	—	 Marco Puerta (40x50) mm
 CORRUGABLE BATIENTE	Sin División	—	—	—	—	—	
 CORRUGABLE POSITIVO	Sin División	—	—	—	—	—	 Marco Bala (80x50) mm
 LEVANTE	Sin División	—	—	—	—	—	
 LEVANTE CON DIVISION	Con División	—	—	—	—	—	

(Cotas en mm)

















Catálogo

Celosías > Gradpanel > Acero >

Serie R

13. Aplicaciones. Tipo de Perfilera. Dimensiones máximas Panel (ancho x alto)* **(Rombo 320)**

Aplicación	Panel	Tipo Perfilera	R 400	R 480	R 500	R 600
						
 MARCO FIJO	Sin División	Perfil Puerta Perfil Bala Marco Puerta Marco Bala	5500 x ∞	5200 x ∞	5200 x ∞	4950 x ∞
 CORRE DERRO	Sin División	—	—	—	—	—
 CORRE DERRO	Con División	—	—	—	—	—
 PRACTICABLE BATIENTE	Sin División	—	—	—	—	—
 PRACTICABLE PREFIJANTE	Sin División	—	—	—	—	—
 PRACTICABLE	Sin División	—	—	—	—	—
 PRACTICABLE CON DIVISIÓN	Con División	—	—	—	—	—
 COBRIPLACABLE BATIENTE	Sin División	—	—	—	—	—
 COBRIPLACABLE PREFIJANTE	Sin División	—	—	—	—	—
 LEVADERO	Sin División	—	—	—	—	—
 LEVADERO CON DIVISIÓN	Con División	—	—	—	—	—

TIPO PERFILERIA



Perfil Puerta (40x50) mm



Perfil Bala (80x50) mm

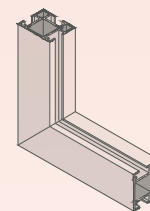

Marco Puerta (40x50) mm

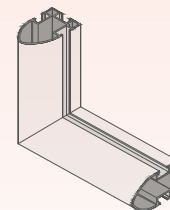

Marco Bala (80x50) mm

(Cotas en mm)















Catálogo

Celosías > Gradpanel > Acero >

Serie R

14. Aplicaciones. Tipo de Perfilera. Dimensiones máximas Panel (ancho x alto)* **(Rombo 470)**

Aplicación	Panel	Tipo Perfilera	R 600	R 620
				
 MARCO FIJO	Sin División	Perfil Puerta Perfil Bala Marco Puerta Marco Bala	6400 x ∞	6400 x ∞
 CORRE DERRO	Sin División	—	—	—
 CORRE DERRO	Con División	—	—	—
 PRACTICABLE BATIENTE	Sin División	—	—	—
 PRACTICABLE FIJANTE	Sin División	—	—	—
 PRACTICABLE	Sin División	—	—	—
 PRACTICABLE CON DIVISIÓN	Con División	—	—	—
 COBRIPLACA BATIENTE	Sin División	—	—	—
 COBRIPLACA FIJANTE	Sin División	—	—	—
 LEVADIZO	Sin División	—	—	—
 LEVADIZO CON DIVISIÓN	Con División	—	—	—

TIPO PERFILERIA



Perfil Puerta (40x50) mm

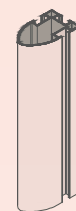

Perfil Bala (80x50) mm

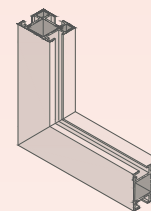

Marco Puerta (40x50) mm

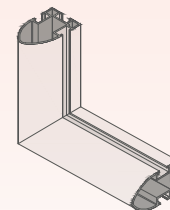

Marco Bala (80x50) mm

(Cotas en mm)



Catálogo

Celosías > Gradpanel > Acero >

Serie R

15. Tabla de accionamientos

Aplicación	Accionamiento	R 200	R 220	R 235	R 250	R 314	R 335	R 400	R 480	R 500	R 600	R 620
	Pomo Retráctil	—	—	—	—	—	—	—	—	—	—	—
	Palanca	—	—	—	—	—	—	—	—	—	—	—
	Mando en lamas	✓	✓	✓	✓	✓	✓	✓	✓	✓	✓	✓
	Gatillo	—	—	—	—	—	—	—	—	—	—	—
	Manivela	—	—	—	—	—	—	—	—	—	—	—
	Cardan	—	—	—	—	—	—	—	—	—	—	—
	Cilindro Lineal	—	—	—	—	—	—	—	—	—	—	—
	Teleflex	○	○	○	○	—	—	—	—	—	—	—
	Motor Lineal	✓	✓	✓	✓	✓	✓	✓	✓	✓	✓	✓
	Motor Tubular	—	—	—	—	—	—	—	—	—	—	—
	Captor Solar + Motor Tubular + Bateria	—	—	—	—	—	—	—	—	—	—	—

✓ Si, ○ consultar, — NO



Catálogo

Celosías > **Gradpanel** > Acero >

Serie R

16. Carta de acabados

Serie R	Acabado									
	Pintura Coil Coating						Pintura al polvo			Anodizado
	Estándar	Complementarios	Efecto	Madera	Bicolor	Otros Ral	Estándar	Complementarios	Otros Ral	Estándar
Marcos y Montantes	—	—	—	—	—	—	✓	○	○	○
Lamas	—	—	—	—	—	—	✓	○	○	—

* Los colores de este catálogo son orientativos, para su elección definitiva consulte una carta de colores reales.

✓ Si, ○ con suplemento, — NO

Gama de colores **GRADCOLORS*** (Marcos, montantes y lamas)

Pintura al polvo Estándar



GH 1343

Aluminio
Blanco

Eq. Ral 9006



GH 2103

Blanco
Tráfico

Eq. Ral 9016

Pintura al polvo Complementarios



GH 1093

Humeado
Oscuro

No Eq. Ral



GH 1103

Humeado
Medio

Eq. Ral 9005



GH 2643

Bronce
Oscuro

No Eq. Ral



GH 7016

Gris
Antracita

Eq. Ral 7016



GH 7022

Gris Sombra

Eq. Ral 7022



GH 1011

Beige Pardo

Eq. Ral 1011



GH 8001

Pardo Ocre

Eq. Ral 8001



GH 8002

Marrón
Señales

Eq. Ral 8002



GH 8003

Pardo Arcilla

Eq. Ral 8003



GH 8011

Pardo Nuez

Eq. Ral 8011

Pintura al polvo Otros RAL

(Si lo prefiere puede escoger cualquier color de la gama RAL)

Anodizado Estándar (Sólo marcos y montantes)



Plata Mate

15 micras



Protección solar y ahorro energético

El sol es una fuente de energía que proporciona a la superficie terrestre aproximadamente 1000 W/m². Dicha energía incide en nuestros edificios proporcionando luz y calor a diario. A priori, esto es enormemente positivo para la eficiencia energética del edificio, puesto que disponemos de una fuente energética limpia (no contaminante) y gratuita. Pero la práctica nos demuestra que si no se controla la exposición del edificio a dicha energía, el sol en lugar de contribuir a su eficiencia energética, aumenta considerablemente su consumo energético.

Para poder efectuar el control requerido, los sistemas de protección solar GRADHERMETIC son una excelente solución, ya que permiten regular fácilmente la energía solar que penetra en el interior del edificio.

La regulación de lamas permite en invierno disminuir el consumo en calefacción, ya que durante el día con la apertura de lamas aumentamos la captación de energía solar hacia el interior del edificio. Durante la noche, con el cierre de lamas ayudamos a mantener la temperatura interior.

En verano, la estrategia de control de regulación debe cambiar, orientando las lamas de modo que impidan el paso de los rayos solares hacia el interior del edificio, permitiendo mantener una agradable temperatura ambiente y consiguiendo un sustancial ahorro en aire acondicionado. Durante la noche, la apertura de lamas y ventanas permite la circulación de aire, reduciendo otra vez las necesidades de aire acondicionado.

Las soluciones orientables también permiten al usuario regular el nivel lumínico del interior del edificio, aumentando el confort visual y eliminando los molestos deslumbramientos. Además, combinados con sistemas de regulación automáticos que controlen la orientación de lamas y los dispositivos de iluminación artificial, se puede optimizar el uso de iluminación natural, con el consecuente ahorro energético que ello supone.



Protección solar y ahorro energético

Ventajas

En invierno

Evitar las pérdidas calóricas por los cristales por la noche.

+

Apertura a los aportes energéticos del sol durante el día.

=

Economizar en calefacción.



En verano

Bloquear las aportaciones calóricas de los rayos del sol.

+

Utilización de la inercia térmica de la construcción para conservar el frescor interior.

=

Limitar la utilización y consumo del sistema de refrigeración manteniendo el confort durante el verano.



Tipos

Hemisferio norte

Fachadas orientación sur

Sistemas de lamas horizontales tanto fijas como móviles. Las lamas verticales no son adecuadas ya que tienen que estar prácticamente cerradas para evitar la entrada del sol.

Fachadas orientación suroeste y sureste

Sistemas de lamas móviles verticales y horizontales. La colocación de lamas fijas requiere un mayor estudio por parte del departamento técnico.

Fachadas orientación este y oeste

La altura solar es escasa, los sistemas idóneos son los de lamas verticales. Las lamas horizontales no responden a las necesidades de esta orientación.

Estudio impacto energético

Según:

- Zona
- Orientación
- Uso
- Transmitancia térmica ventanas
- Tipo de protección solar

Resultado:



-10%

AHORRO ENERGÉTICO CALEFACCIÓN



-40%

AHORRO ENERGÉTICO REFRIGERACIÓN





Gradpanel Serie R 314

GRADHERMETIC®

Fábrica y oficinas:

Avda. Béjar, 345
08226 Terrassa. BARCELONA. España

Tel. 0034 937 354 408
Fax 0034 937 356 543

info@gradhermetic.com
www.gradhermetic.com

