

Catálogo

Celosías > **Gradpanel** > Aluminio >



Serie E



Gradpanel Serie E 200 Bz



Catálogo

Celosías > Gradpanel > Aluminio >

Serie E

Índice

1. Tipos de lamas	Página 04
2. Tipo de lamas pequeñas	Página 05-08
3. Tipo de lamas grandes	Página 09-12
4. Tipo de lamas trapezoidales	Página 13-16
5. Relación de distancias entre fijaciones y separación de montantes	Página 18-21
6. Tabla de aplicaciones lamas pequeñas	Página 22
7. Tabla de aplicaciones lamas grandes	Página 23
8. Tabla de aplicaciones lamas trapezoidales	Página 24
9. Tabla de accionamientos	Página 25
10. Carta de acabados	Página 26
11. Protección solar y ahorro energético	Página 27-28



Catálogo

Celosías > **Gradpanel** > Aluminio >
Serie E

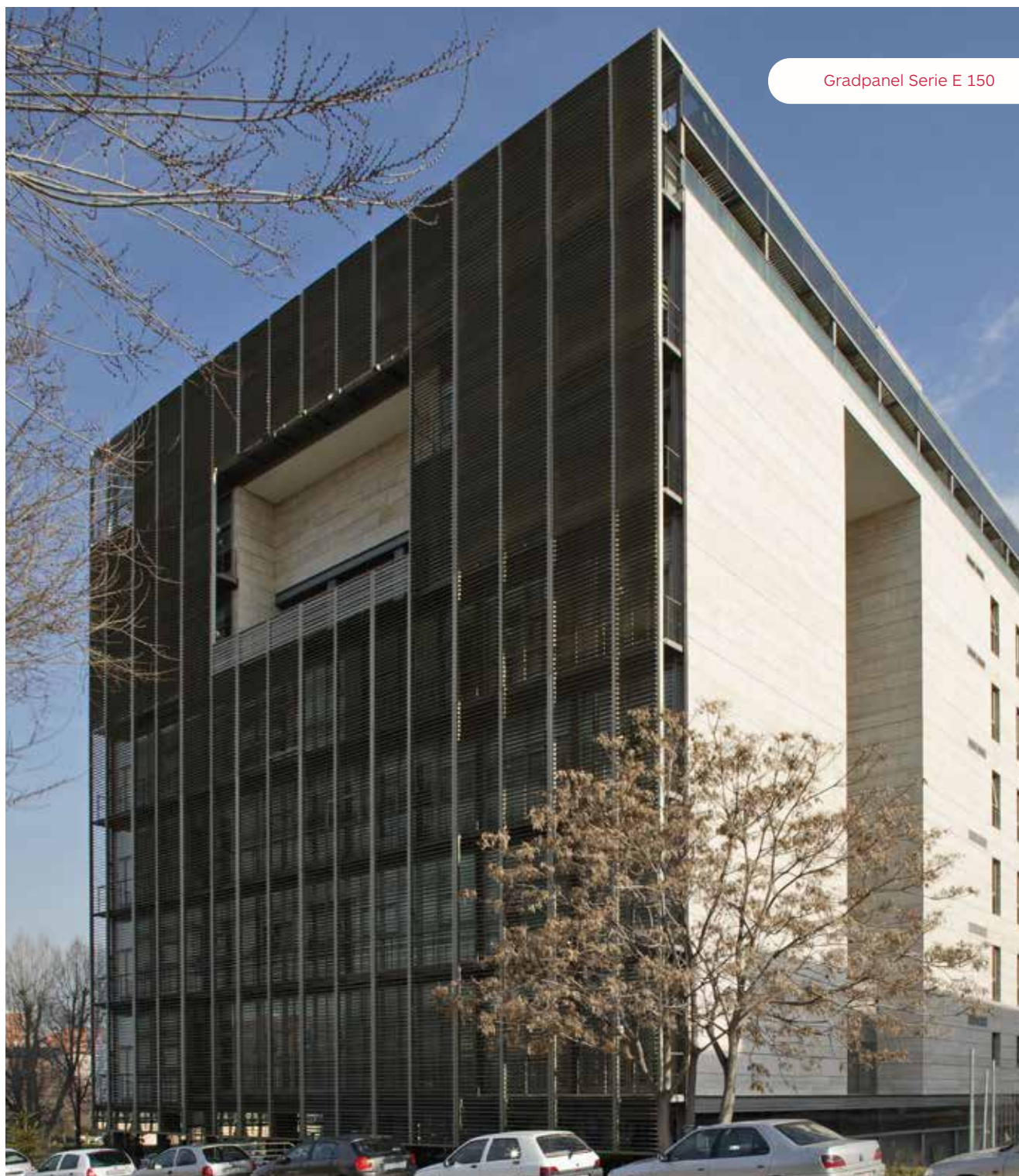

Gradpanel Serie E 150



Catálogo

Celosías > Gradpanel > Aluminio >

Serie E

1. Tipos de Lamas



E 77



E 100



E 150



E 120



E 145



E 190



E 170 Bz



E 200 Bz



E 220



E 250



E 300



E 400



Catálogo

Celosías > **Gradpanel** > Aluminio >
Serie E



Gradpanel Serie E 77



Catálogo

Celosías > Gradpanel > Aluminio >

Serie E



Infografía: E 150

2. Tipos de Lamas Serie E (Lamas pequeñas)



E 145



E 120



E 150



E 100



E 77



Catálogo

Celosías > Gradpanel > Aluminio >

Serie E

2.1 Descripción Serie E (Lamas pequeñas)

Celosías de aluminio de lamas fijas y orientables, tubulares extruidas, colocadas en horizontal o verticalmente, en aplicación paramentos sobre montantes de aluminio extruido, con soporte portalamas de aluminio para lamas fijas; para el resto de aplicaciones las lamas fijas u orientables irán situadas entre marcos vistos de aluminio extruido.

2.2 Productos Serie E (Lamas pequeñas)

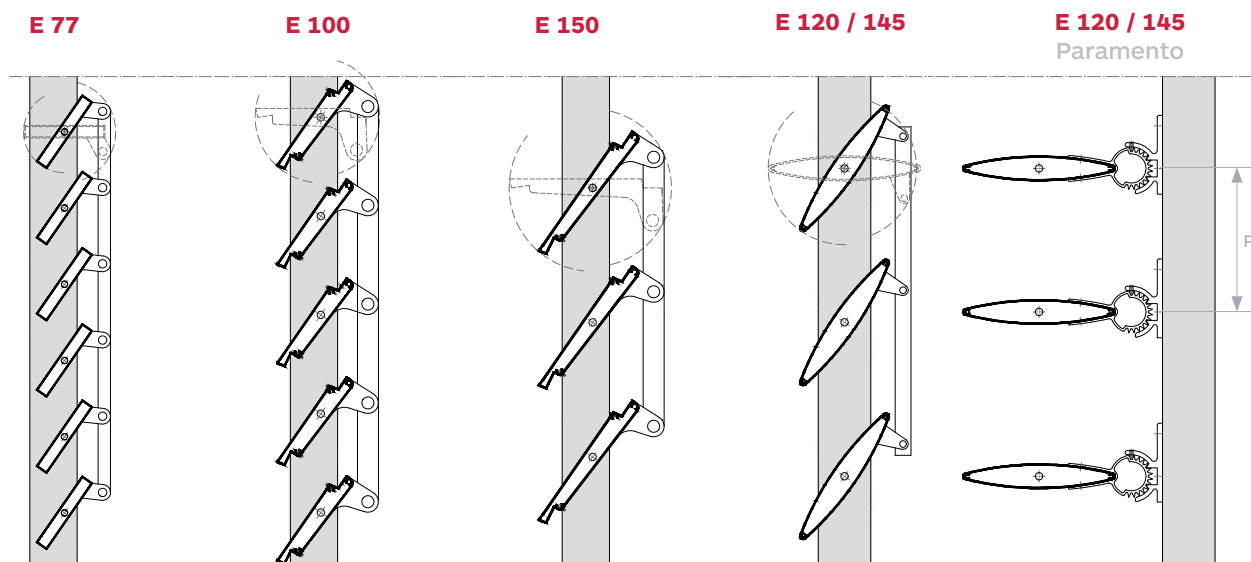

P. estándar E 120 = 110 mm
P. estándar E 145 = 132 mm

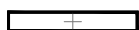

77 x 12 mm



105 x 19 mm



145 x 19 mm

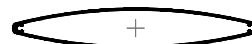

120 x 18 mm
145 x 23 mm

2.3 Uso de Aplicaciones Serie E (Lamas pequeñas)

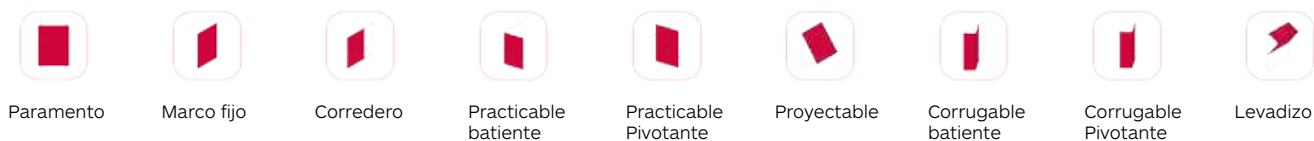

Catálogo

Celosías > Gradpanel > Aluminio >

Serie E

2.4 Tipos de perfiles para marcos* Serie E (Lamas pequeñas)

*Según tabla aplicaciones página 22

40 x 25 mm



40 x 40 mm



50 x 50 mm



PPA 120
(43 x 40 mm)



45 x 35 mm
(45 x 60 mm)



80 x 45 mm
(80 x 45 mm)



2.5 Tipos de montantes* Serie E (Lamas pequeñas)

*Según tabla aplicaciones página 18

40 x 40 mm



50 x 50 mm



110 x 50 mm

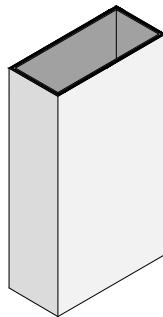

2.6 Soporte lama fija Serie E (Lamas pequeñas)

Horizontal
y Vertical

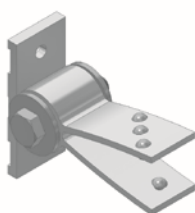

Solo
Horizontal

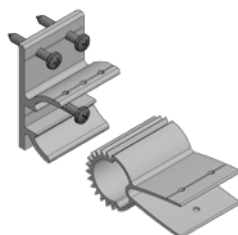

Catálogo

Celosías > **Gradpanel** > Aluminio >
Serie E



Catálogo

Celosías > Gradpanel > Aluminio >

Serie E



Infografía: E 250

3. Tipos de Lamas Serie E (Lamas grandes)



E 400

E 300

E 250

E 220

E 190



Catálogo

Celosías > Gradpanel > Aluminio >

Serie E

3.1 Descripción Serie E (Lamas grandes)

Celosías de aluminio de grandes lamas fijas y orientables en forma elíptica, tubulares extruidas, colocadas en horizontal o verticalmente, en aplicación paramentos sobre montantes de aluminio extruido, con soporte portalamas de aluminio para lamas fijas; y para aplicación marco fijo entre marcos vistos de aluminio extruido para lamas orientables.

3.2 Productos Serie E (Lamas grandes)

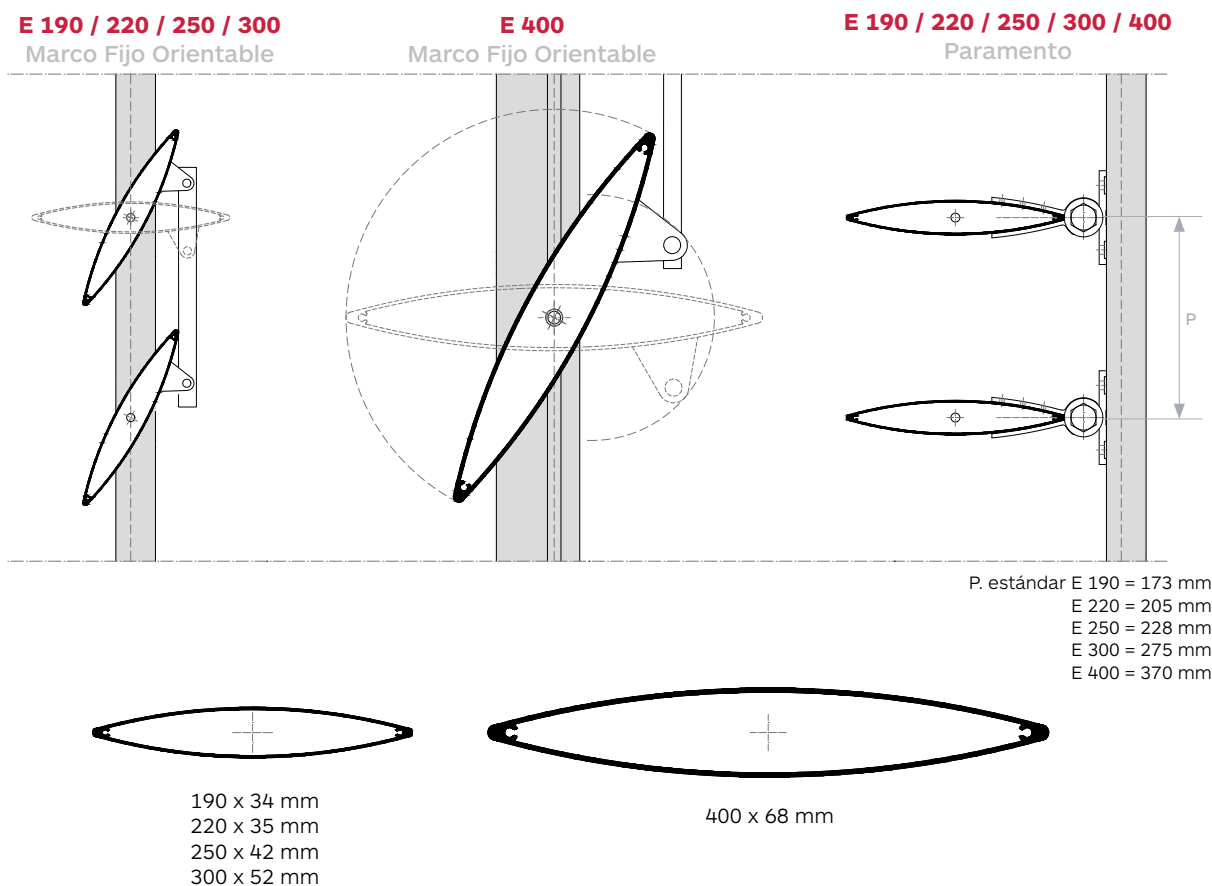

3.3 Uso de Aplicaciones Serie E (Lamas grandes)

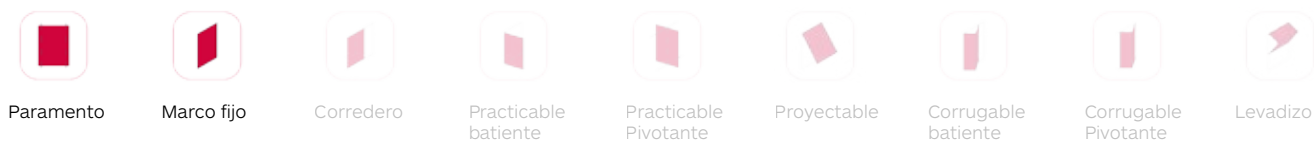

Catálogo

Celosías > Gradpanel > Aluminio >

Serie E

3.4 Tipos de perfiles para marcos* Serie E (Lamas grandes)

*Según tabla aplicaciones página 23

50 x 50 mm



3.5 Tipos de montantes Serie E (Lamas grandes)

*Paramento página 18-20; resto aplicaciones página 23

40 x 40 mm



50 x 50 mm



110 x 50 mm

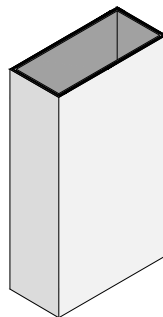

Perfil Puerta
(40 x 50)

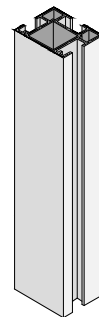

Perfil Bala
(80 x 50)

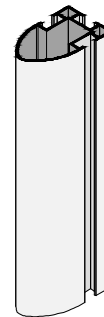

3.6 Soporte lama fija Serie E (Lamas grandes)

Horizontal
y Vertical

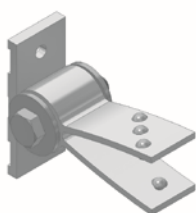

Solo
Horizontal

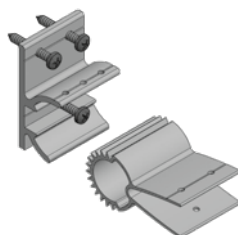

Catálogo

Celosías > Gradpanel > Aluminio >
Serie E



Gradpanel Serie E 200 Bz



Catálogo

Celosías > Gradpanel > Aluminio >

Serie E

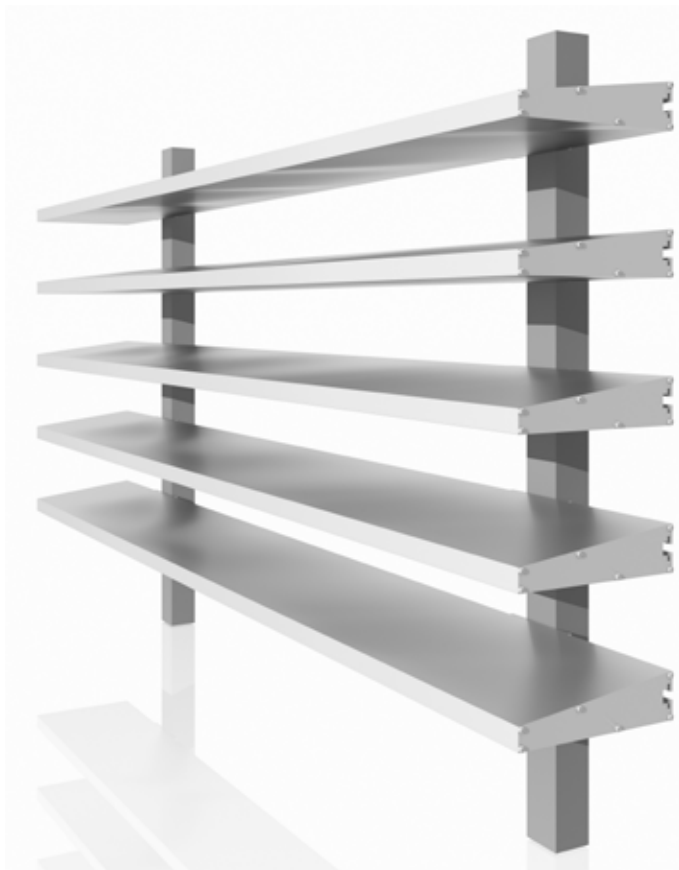

Infografía: E 200 Bz

4. Tipos de Lamas Serie E (Lamas trapezoidales)



E 200 Bz



E 170 Bz



Catálogo

Celosías > Gradpanel > Aluminio >

Serie E

4.1 Descripción Serie E (Lamas trapezoidales)

Celosías de aluminio de lamas fijas y orientables en forma trapezoidal, tubulares extruidas, colocadas en horizontal o verticalmente, en aplicación paramentos sobre omegas o montantes de aluminio extruido para lamas fijas y para aplicación marco fijo entre marcos vistos de aluminio extruido para lamas orientables.

4.2 Productos Serie E (Lamas trapezoidales)

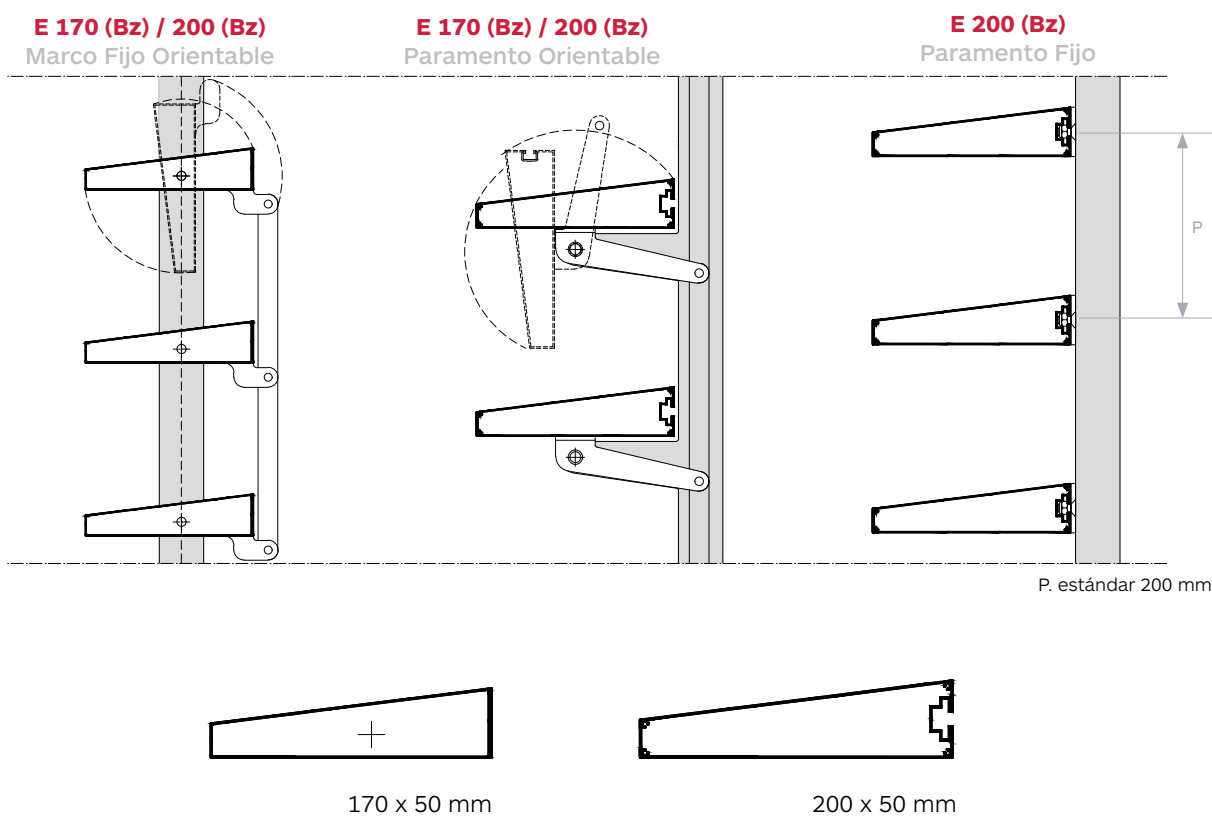

4.3 Uso de Aplicaciones Serie E (Lamas trapezoidales)



Catálogo

Celosías > Gradpanel > Aluminio >

Serie E

4.4 Tipos de perfiles para **marcos** (Lamas trapezoidales)

*Según tabla aplicaciones página 24

50 x 50 mm



4.5 Tipos de montantes* (Lamas trapezoidales)

*Paramento página 21; resto aplicaciones página 24

50 x 50 mm



110 x 50 mm

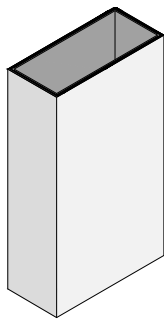

Perfil Sierra
(80 x 50 mm)

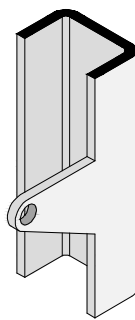

Omega
(100 x 50 mm)



Catálogo

Celosías > Gradpanel > Aluminio >

Serie E

Especificaciones Técnicas

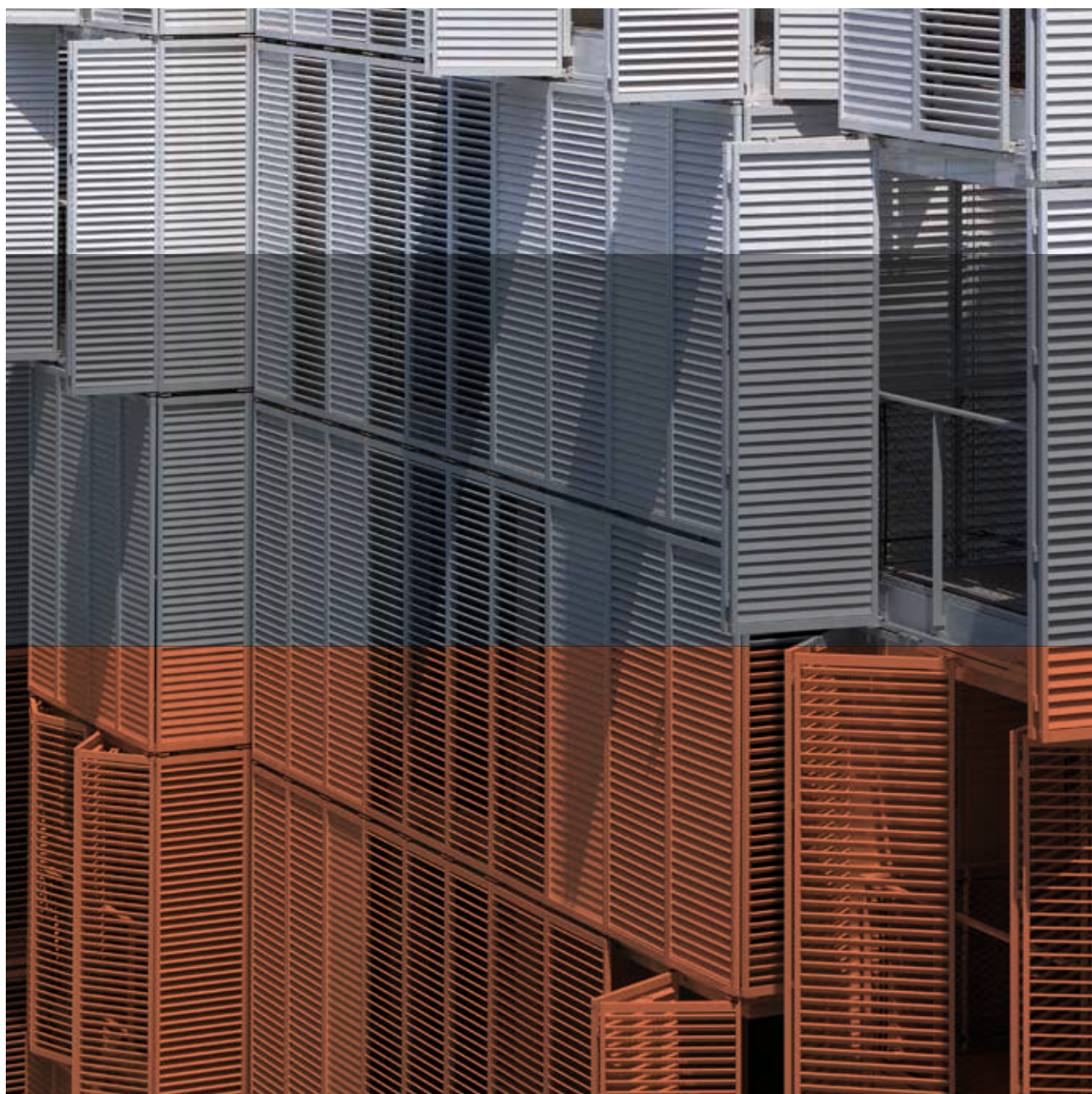

5. Relación de distancias entre fijaciones y separación de montantes (Paramentos)

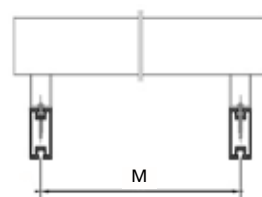
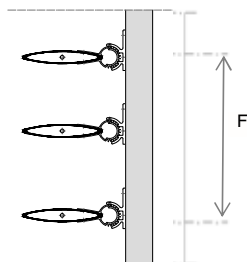
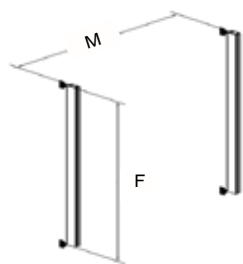

M = Separación entre ejes de montantes
F = Separación entre fijaciones

Serie E 120

M (cm)	F (cm)			
	Tipo de montante			
	40x40x1,5	50x50x2	50x50x3	110x50x3
100	242	269	302	378
120	228	253	284	355
140	217	241	270	338
160	207	230	258	323
180	199	221	248	310

Calculado con un P estandar de 120 mm y 45°

M (cm)	F (cm)			
	Tipo de montante			
	40x40x1,5	50x50x2	50x50x3	110x50x3
100	183	251	282	352
120	172	236	265	332
140	164	225	252	315
160	157	215	241	301
180	151	207	232	290

Calculado con un P estandar de 120 mm y 30°

M (cm)	F (cm)			
	Tipo de montante			
	40x40x1,5	50x50x2	50x50x3	110x50x3
100	175	240	269	336
120	164	226	253	317
140	156	214	241	301
160	149	205	230	288
180	144	197	221	277

Calculado con un P estandar de 120 mm y 0°

Serie E 145

M (cm)	F (cm)			
	Tipo de montante			
	40x40x2	50x50x2	50x50x3	110x50x3
100	242	269	302	378
120	228	253	284	355
140	217	241	270	338
160	207	230	258	323
180	199	221	248	310
200	192	214	240	300
220	186	207	232	290
240	181	201	226	282

Calculado con un P estandar de 145 mm y 45°

M (cm)	F (cm)			
	Tipo de montante			
	40x40x2	50x50x2	50x50x3	110x50x3
100	183	251	282	352
120	172	236	265	332
140	164	225	252	315
160	157	215	241	301
180	151	207	232	290
200	145	199	224	280
220	141	193	217	271
240	137	188	211	263

Calculado con un P estandar de 145 mm y 30°

M (cm)	F (cm)			
	Tipo de montante			
	40x40x2	50x50x2	50x50x3	110x50x3
100	175	240	269	336
120	164	226	253	317
140	156	214	241	301
160	149	205	230	288
180	144	197	221	277
200	139	190	214	267
220	134	184	207	259
240	131	179	201	251

Calculado con un P estandar de 145 mm y 0°

Serie E 190

M (cm)	F (cm)			
	Tipo de montante			
	40x40x2	50x50x2	50x50x3	110x50x3
100	242	269	302	378
120	228	253	284	355
140	217	241	270	338
160	207	230	258	323
180	199	221	248	310
200	192	214	240	300
220	186	207	232	290
240	181	201	226	282
260	176	196	220	275
280	172	191	214	268
300	168	187	209	262
320	164	183	205	256

Calculado con un P estandar de 190 mm y 45°

M (cm)	F (cm)			
	Tipo de montante			
	40x40x2	50x50x2	50x50x3	110x50x3
100	183	251	282	352
120	172	236	265	332
140	164	225	252	315
160	157	215	241	301
180	151	207	232	290
200	145	199	224	280
220	141	193	217	271
240	137	188	211	263
260	133	183	205	256
280	130	178	200	250
300	127	174	195	244
320	124	171	191	239

Calculado con un P estandar de 190 mm y 30°

M (cm)	F (cm)			
	Tipo de montante			
	40x40x2	50x50x2	50x50x3	110x50x3
100	175	240	269	336
120	164	226	253	317
140	156	214	241	301
160	149	205	230	288
180	144	197	221	277
200	139	190	214	267
220	134	184	207	259
240	131	179	201	251
260	127	174	196	245
280	124	170	191	239
300	121	166	187	233
320	119	163	183	228

Calculado con un P estandar de 190 mm y 0°



5. Relación de distancias entre fijaciones y separación de montantes (Paramentos)

Serie E 220 L

M (cm)	F (cm)				M (cm)	F (cm)				M (cm)	F (cm)			
	Tipo de montante					Tipo de montante					Tipo de montante			
	40x40x2	50x50x2	50x50x3	110x50x3		40x40x2	50x50x2	50x50x3	110x50x3		40x40x2	50x50x2	50x50x3	110x50x3
100	242	269	302	378	100	183	251	282	352	100	175	240	269	336
120	228	253	284	355	120	172	236	265	332	120	164	226	253	317
140	217	241	270	338	140	164	225	252	315	140	156	214	241	301
160	207	230	258	323	160	157	215	241	301	160	149	205	230	288
180	199	221	248	310	180	151	207	232	290	180	144	197	221	277
200	192	214	240	300	200	145	199	224	280	200	139	190	214	267
220	186	207	232	290	220	141	193	217	271	220	134	184	207	259
240	181	201	226	282	240	137	188	211	263	240	131	179	201	251
260	176	196	220	275	260	133	183	205	256	260	127	174	196	245

Calculado con un P estandar de 220 mm y 45°

Calculado con un P estandar de 220 mm y 30°

Calculado con un P estandar de 220 mm y 0°

Serie E 220

M (cm)	F (cm)				M (cm)	F (cm)				M (cm)	F (cm)			
	Tipo de montante					Tipo de montante					Tipo de montante			
	40x40x2	50x50x2	50x50x3	110x50x3		40x40x2	50x50x2	50x50x3	110x50x3		40x40x2	50x50x2	50x50x3	110x50x3
100	242	269	302	378	100	183	251	282	352	100	175	240	269	336
120	228	253	284	355	120	172	236	265	332	120	164	226	253	317
140	217	241	270	338	140	164	225	252	315	140	156	214	241	301
160	207	230	258	323	160	157	215	241	301	160	149	205	230	288
180	199	221	248	310	180	151	207	232	290	180	144	197	221	277
200	192	214	240	300	200	145	199	224	280	200	139	190	214	267
220	186	207	232	290	220	141	193	217	271	220	134	184	207	259
240	181	201	226	282	240	137	188	211	263	240	131	179	201	251
260	176	196	220	275	260	133	183	205	256	260	127	174	196	245
280	172	191	214	268	280	130	178	200	250	280	124	170	191	239
300	168	187	209	262	300	127	174	195	244	300	121	166	187	233
320	164	183	205	256	320	124	171	191	239	320	119	163	183	228

Calculado con un P estandar de 220 mm y 45°

Calculado con un P estandar de 220 mm y 30°

Calculado con un P estandar de 220 mm y 0°

Serie E 250

M (cm)	F (cm)				M (cm)	F (cm)				M (cm)	F (cm)			
	Tipo de montante					Tipo de montante					Tipo de montante			
	40x40x2	50x50x2	50x50x3	110x50x3		40x40x2	50x50x2	50x50x3	110x50x3		40x40x2	50x50x2	50x50x3	110x50x3
100	242	269	302	378	100	183	251	282	352	100	175	240	269	336
120	228	253	284	355	120	172	236	265	332	120	164	226	253	317
140	217	241	270	338	140	164	225	252	315	140	156	214	241	301
160	207	230	258	323	160	157	215	241	301	160	149	205	230	288
180	199	221	248	310	180	151	207	232	290	180	144	197	221	277
200	192	214	240	300	200	145	199	224	280	200	139	190	214	267
220	186	207	232	290	220	141	193	217	271	220	134	184	207	259
240	181	201	226	282	240	137	188	211	263	240	131	179	201	251
260	176	196	220	275	260	133	183	205	256	260	127	174	196	245
280	172	191	214	268	280	130	178	200	250	280	124	170	191	239
300	168	187	209	262	300	127	174	195	244	300	121	166	187	233
320	164	183	205	256	320	124	171	191	239	320	119	163	183	228
340	161	179	201	251	340	122	167	187	234	340	116	160	181	224
360	158	176	197	246	360	119	164	184	230	360	114	157	179	220

Calculado con un P estandar de 250 mm y 45°

Calculado con un P estandar de 250 mm y 30°

Calculado con un P estandar de 250 mm y 0°



5. Relación de distancias entre fijaciones y separación de montantes (Paramentos)

Serie E 300

M (cm)	F (cm)				M (cm)	F (cm)				M (cm)	F (cm)			
	Tipo de montante					Tipo de montante					Tipo de montante			
	40x40x2	50x50x2	50x50x3	110x50x3		40x40x2	50x50x2	50x50x3	110x50x3		40x40x2	50x50x2	50x50x3	110x50x3
100	242	269	302	378	100	183	251	282	352	100	175	240	269	336
120	228	253	284	355	120	172	236	265	332	120	164	226	253	317
140	217	241	270	338	140	164	225	252	315	140	156	214	241	301
160	207	230	258	323	160	157	215	241	301	160	149	205	230	288
180	199	221	248	310	180	151	207	232	290	180	144	197	221	277
200	192	214	240	300	200	145	199	224	280	200	139	190	214	267
220	186	207	232	290	220	141	193	217	271	220	134	184	207	259
240	181	201	226	282	240	137	188	211	263	240	131	179	201	251
260	176	196	220	275	260	133	183	205	256	260	127	174	196	245
280	172	191	214	268	280	130	178	200	250	280	124	170	191	239
300	168	187	209	262	300	127	174	195	244	300	121	166	187	233
320	164	183	205	256	320	124	171	191	239	320	119	163	183	228
340	161	179	201	251	340	122	167	187	234	340	116	160	181	224
360	158	176	197	246	360	119	164	184	230	360	114	157	179	220
380	155	154	194	242	380	117	154	181	226	380	112	154	172	216
400	153	151	190	238	400	115	151	178	222	400	110	151	170	212
420	150	149	187	234	420	114	149	175	218	420	108	149	167	209
440	148	146	184	230	440	112	146	172	215	440	107	146	164	205

Calculado con un P estandar de 300 mm y 45°

Calculado con un P estandar de 300 mm y 30°

Calculado con un P estandar de 300 mm y 0°

Serie E 400

M (cm)	F (cm)				M (cm)	F (cm)				M (cm)	F (cm)			
	Tipo de montante					Tipo de montante					Tipo de montante			
	40x40x2	50x50x2	50x50x3	110x50x3		40x40x2	50x50x2	50x50x3	110x50x3		40x40x2	50x50x2	50x50x3	110x50x3
100	242	269	302	378	100	183	251	282	352	100	175	240	269	336
120	228	253	284	355	120	172	236	265	332	120	164	226	253	317
140	217	241	270	338	140	164	225	252	315	140	156	214	241	301
160	207	230	258	323	160	157	215	241	301	160	149	205	230	288
180	199	221	248	310	180	151	207	232	290	180	144	197	221	277
200	192	214	240	300	200	145	199	224	280	200	139	190	214	267
220	186	207	232	290	220	141	193	217	271	220	134	184	207	259
240	181	201	226	282	240	137	188	211	263	240	131	179	201	251
260	176	196	220	275	260	133	183	205	256	260	127	174	196	245
280	172	191	214	268	280	130	178	200	250	280	124	170	191	239
300	168	187	209	262	300	127	174	195	244	300	121	166	187	233
320	164	183	205	256	320	124	171	191	239	320	119	163	183	228
340	161	179	201	251	340	122	167	187	234	340	116	160	181	224
360	158	176	197	246	360	119	164	184	230	360	114	157	179	220
380	155	154	194	242	380	117	154	181	226	380	112	154	172	216
400	153	151	190	238	400	115	151	178	222	400	110	151	170	212
420	150	149	187	234	420	114	149	175	218	420	108	149	167	209
440	148	146	184	230	440	112	146	172	215	440	107	146	164	205
460	146	144	182	227	460	110	151	170	212	460	105	144	162	202
480	142	140	177	221	480	109	149	167	209	480	104	142	160	199
500	142	140	177	221	500	107	147	165	206	500	102	140	157	197
520	140	138	174	218	520	106	145	163	203	520	101	138	155	194
540	138	136	172	215	540	104	143	161	201	540	100	135	153	192

Calculado con un P estandar de 400 mm y 45°

Calculado con un P estandar de 400 mm y 30°

Calculado con un P estandar de 400 mm y 0°



5. Relación de distancias entre fijaciones y separación de montantes (Paramentos)

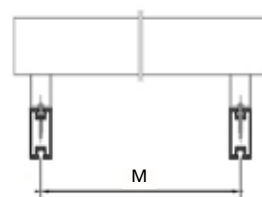
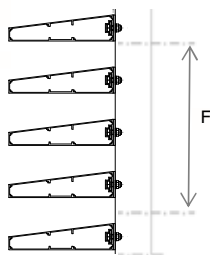
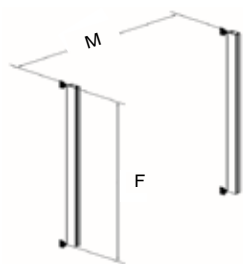

M = Separación entre ejes de montantes
F = Separación entre fijaciones

Serie E 200 Bz (horizontal)

M (cm)	F (cm)		
	Tipo de montante		
	Omega	50x50x3	110x50x3
80	217	394	493
100	201	366	458
120	189	344	431
140	180	327	409
160	172	313	391
180	165	301	376
200	160	291	363
220	155	281	352
240	150	273	342
260	146	266	333
280	143	260	325
300	139	254	317
320	136	248	311
340	134	243	304
360	131	239	299
375	129	235	293

Calculado con un P estandar de 200 mm

Serie E 200 Bz (vertical)

M (cm)	F (cm)		
	Tipo de montante		
	Omega	50x50x3	110x50x3
80	127	255	359
100	118	237	333
120	111	223	314
140	105	212	298
160	101	203	285
180	97	195	274
200	93	188	265
220	90	182	256
240	88	177	249
260	86	172	242
280	83	168	236
300	82	164	231
320	80	161	226
340	78	158	222
360	77	155	217
375	75	152	214
400	74	149	210

Calculado con un P estandar de 200 mm

















Catálogo

Celosías > Gradpanel > Aluminio >

Serie E

6. Aplicaciones. Tipo de Perfilera. Dimensiones máximas Panel (ancho x alto)*

Aplicación	Panel	Tipo Perfilera	E 77	E 100	E 150	E 120	E 145
							
	Sin División	40x25 / 40x40 / 50x50 / 45x35 / 80x45	1590 x ∞	1800 x ∞	2200 x ∞	1850 x ∞	2350 x ∞
	Sin División	PPA 120	1600 x 2250	1800 x 2150	2200 x 2050	1850 x 2100	2350 x 2000
		45x35	1600 x 2650	1800 x 2500	2200 x 2400	1850 x 2500	2350 x 2350
		80x45	1600 x 4800	1800 x 4550	2200 x 4300	1850 x 4450	2350 x 4250
	Con División	PPA 120	3200 x 1700	3600 x 1650	3600 x 1650	3600 x 1650	3600 x 1650
		45x35	3200 x 2100	3600 x 2000	3600 x 2000	3600 x 2000	3600 x 2000
		80x45	3200 x 3850	3600 x 3700	3600 x 3700	3600 x 3700	3600 x 3700
	Sin División	45x35	1000 x 2500	1000 x 2500	1000 x 2500	1000 x 2500	1000 x 2500
		PPA 120	800 x 2500	800 x 2500	700 x 2500	800 x 2500	700 x 2500
	Sin División	45x35	1200 x 3000	1200 x 3000	1000 x 3000	1200 x 3000	1000 x 3000
	Sin División	PPA 120	1590 x 2000	1800 x 2000	1800 x 2000	1800 x 2000	1800 x 2000
	Con División	PPA 120	1800 x 2000	1800 x 2500	1800 x 2000	1800 x 2000	1800 x 2000
	Sin División	PPA 120	600 x 2500 (hoja)	600 x 2500 (hoja)	600 x 2500 (hoja)	600 x 2500 (hoja)	600 x 2500 (hoja)
	Sin División	45x35	1000 x 3000 (hoja)	1000 x 3000 (hoja)	1000 x 3000 (hoja)	1000 x 3000 (hoja)	1000 x 3000 (hoja)
	Sin División	PPA 120	1590 x 2500 (máx 3 m²)	1800 x 2500 (máx 3 m²)	2200 x 2500 (máx 3 m²)	1850 x 2500 (máx 3 m²)	2350 x 2500 (máx 3 m²)
	Con División	PPA 120	2500 x 2500 (máx 3 m²)	2500 x 2500 (máx 3 m²)	2500 x 2500 (máx 3 m²)	2500 x 2500 (máx 3 m²)	2500 x 2500 (máx 3 m²)

TIPO PERFILERIA



40 x 25 mm



40 x 40 mm

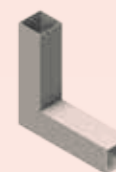

50 x 50 mm



45 x 35 (45x60 mm)

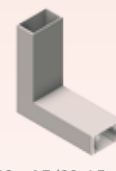

80 x 45 (80x45 mm)



PPA 120 (43x40 mm)

(Cotas en mm)



Catálogo

Celosías > Gradpanel > Aluminio >

Serie E

7. Aplicaciones. Tipo de Perfilera. Dimensiones máximas Panel (ancho x alto)*.

Aplicación	Panel	Tipo Perfilera	E 190	E 220	E 250	E 300	E 400
							
 MARCO FIJO	Sin División	50x50 / 50x50x2 /	3200 x ∞	3269 x ∞	3769 x ∞	4614 x ∞	—
		Puerta / Bala	—	—	—	—	5606 x ∞
 CORTE DE 90	Sin División	—	—	—	—	—	—
 CORTE DE 90	Con División	—	—	—	—	—	—
 PRACTICABLE BATIENTE	Sin División	—	—	—	—	—	—
 PRACTICABLE POSITIVO	Sin División	—	—	—	—	—	—
 PRACTICABLE	Sin División	—	—	—	—	—	—
 PRACTICABLE CON DIVISION	Con División	—	—	—	—	—	—
 CORRUGABLE BATIENTE	Sin División	—	—	—	—	—	—
 CORRUGABLE POSITIVO	Sin División	—	—	—	—	—	—
 LEVANZO	Sin División	—	—	—	—	—	—
 LEVANZO CON DIVISION	Con División	—	—	—	—	—	—

TIPO PERFILERIA



50 x 50 mm



50 x 50 x 2 mm



Perfil Puerta (40x50 mm)



Perfil Bala (80x50 mm)

(Cotas en mm)



















Catálogo

Celosías > Gradpanel > Aluminio >

Serie E

8. Aplicaciones. Tipo de Perfilera. Dimensiones máximas Panel (ancho x alto)*.

Aplicación	Panel	Tipo Perfilera	E 170 Bz	E 200 Bz	TIPO PERFILERIA
					
 MARCO FIJO	Sin División	50x50 / 50x50x2 / Puerta / Bala	2800 x ∞	3750 x ∞	 50x50 mm
 CORRIENTE DE 90	Sin División	—	—	—	
 CORRIENTE DE 90	Con División	—	—	—	
 PRACTICABLE BATIENTE	Sin División	—	—	—	 50x50x2 mm
 PRACTICABLE FIJO	Sin División	—	—	—	
 PRACTICABLE	Sin División	—	—	—	
 PRACTICABLE CON DIVISION	Con División	—	—	—	 Perfil Puerta (40x50 mm)
 CORRIENTE BATIENTE	Sin División	—	—	—	
 CORRIENTE FIJO	Sin División	—	—	—	
 LEVANZO	Sin División	—	—	—	 Perfil Bala (80x50 mm)
 LEVANZO CON DIVISION	Con División	—	—	—	

(Cotas en mm)



Catálogo

Celosías > Gradpanel > Aluminio >

Serie E

9. Tabla de accionamientos para marcos fijos

Aplicación	Accionamiento	E 77	E 100	E 120	E 145	E 150	E 170 Bz	E 190	E 200 Bz	E 220	E 250	E 300	E 400
	Pomo Retráctil	O	✓	✓	✓	✓	O	✓	O	✓	—	—	—
	Palanca	—	—	—	—	—	—	—	—	—	—	—	—
	Mando en lamas	—	—	✓	✓	—	—	✓	—	✓	✓	✓	✓
	Gatillo	—	—	—	—	—	—	✓	—	✓	—	—	—
	(*) Manivela	O	O	O	O	—	—	—	—	—	—	—	—
	Cardan	—	—	—	—	—	—	—	—	—	—	—	—
	Cilindro Lineal	✓	✓	✓	✓	✓	—	—	—	—	—	—	—
	Teleflex	O	O	O	O	O	O	O	O	O	O	O	O
	(*) Motor Lineal	✓	✓	✓	✓	✓	✓	✓	✓	✓	✓	✓	✓
	(*) Motor Tubular	✓	O	O	O	O	—	—	—	—	—	—	—
	(*) Captor Solar + Motor Tubular + Bateria	✓	O	O	O	O	—	—	—	—	—	—	—

(*) Sólo con marco 50x50 mm

✓ Si, O consultar, — NO



Catálogo

Celosías > Gradpanel > Aluminio >

Serie E

10. Carta de acabados

Serie E	Acabado									
	Pintura Coil Coating						Pintura al polvo			Anodizado
	Estándar	Complementarios	Efecto	Madera	Bicolor	Otros Ral	Estándar	Complementarios	Otros Ral	Estándar
Marcos y Montantes	—	—	—	—	—	—	✓	○	○	✓
Lamas	—	—	—	—	—	—	✓	○	○	✓

* Los colores de este catálogo son orientativos, para su elección definitiva consulte una carta de colores reales.

✓ Si, ○ con suplemento, — NO

Gama de colores **GRADCOLORS*** (Marcos, montantes y lamas)

Pintura al polvo Estándar



GH 1343

Aluminio
Blanco

Eq. Ral 9006



GH 2103

Blanco
Tráfico

Eq. Ral 9016

Pintura al polvo Complementarios



GH 1093

Humeado
Oscuro

No Eq. Ral



GH 1103

Humeado
Medio

Eq. Ral 9005



GH 2643

Bronce
Oscuro

No Eq. Ral



GH 7016

Gris
Antracita

Eq. Ral 7016



GH 7022

Gris Sombra

Eq. Ral 7022



GH 1011

Beige Pardo

Eq. Ral 1011



GH 8001

Pardo Ocre

Eq. Ral 8001



GH 8002

Marrón
Señales

Eq. Ral 8002



GH 8003

Pardo Arcilla

Eq. Ral 8003



GH 8011

Pardo Nuez

Eq. Ral 8011

Pintura al polvo Otros RAL

(Si lo prefiere puede escoger cualquier color de la gama RAL)

Anodizado Estándar



Plata Mate

15 micras



Protección solar y ahorro energético

El sol es una fuente de energía que proporciona a la superficie terrestre aproximadamente 1000 W/m². Dicha energía incide en nuestros edificios proporcionando luz y calor a diario. A priori, esto es enormemente positivo para la eficiencia energética del edificio, puesto que disponemos de una fuente energética limpia (no contaminante) y gratuita. Pero la práctica nos demuestra que si no se controla la exposición del edificio a dicha energía, el sol en lugar de contribuir a su eficiencia energética, aumenta considerablemente su consumo energético.

Para poder efectuar el control requerido, los sistemas de protección solar GRADHERMETIC son una excelente solución, ya que permiten regular fácilmente la energía solar que penetra en el interior del edificio.

La regulación de lamas permite en invierno disminuir el consumo en calefacción, ya que durante el día con la apertura de lamas aumentamos la captación de energía solar hacia el interior del edificio. Durante la noche, con el cierre de lamas ayudamos a mantener la temperatura interior.

En verano, la estrategia de control de regulación debe cambiar, orientando las lamas de modo que impidan el paso de los rayos solares hacia el interior del edificio, permitiendo mantener una agradable temperatura ambiente y consiguiendo un sustancial ahorro en aire acondicionado. Durante la noche, la apertura de lamas y ventanas permite la circulación de aire, reduciendo otra vez las necesidades de aire acondicionado.

Las soluciones orientables también permiten al usuario regular el nivel lumínico del interior del edificio, aumentando el confort visual y eliminando los molestos deslumbramientos. Además, combinados con sistemas de regulación automáticos que controlen la orientación de lamas y los dispositivos de iluminación artificial, se puede optimizar el uso de iluminación natural, con el consecuente ahorro energético que ello supone.



Protección solar y ahorro energético

Ventajas

En invierno

Evitar las pérdidas calóricas por los cristales por la noche.

+

Apertura a los aportes energéticos del sol durante el día.

=

Economizar en calefacción.



En verano

Bloquear las aportaciones calóricas de los rayos del sol.

+

Utilización de la inercia térmica de la construcción para conservar el frescor interior.

=

Limitar la utilización y consumo del sistema de refrigeración manteniendo el confort durante el verano.



Tipos

Hemisferio norte

Fachadas orientación sur

Sistemas de lamas horizontales tanto fijas como móviles. Las lamas verticales no son adecuadas ya que tienen que estar prácticamente cerradas para evitar la entrada del sol.

Fachadas orientación suroeste y sureste

Sistemas de lamas móviles verticales y horizontales. La colocación de lamas fijas requiere un mayor estudio por parte del departamento técnico.

Fachadas orientación este y oeste

La altura solar es escasa, los sistemas idóneos son los de lamas verticales. Las lamas horizontales no responden a las necesidades de esta orientación.

Estudio impacto energético

Según:

- Zona
- Orientación
- Uso
- Transmitancia térmica ventanas
- Tipo de protección solar

Resultado:



-10%

AHORRO ENERGÉTICO CALEFACCIÓN



-40%

AHORRO ENERGÉTICO REFRIGERACIÓN





Gradpanel Serie E 150

GRADHERMETIC®

Fábrica y oficinas:

Avda. Béjar, 345

08226 Terrassa. BARCELONA. España

Tel. 0034 937 354 408

Fax 0034 937 356 543

info@gradhermetic.com

www.gradhermetic.com

